

A System Level Solution for Power Quality Problems

U.Harish Padiyar, S. S. Mahant Shetti, *Member, IEEE*, and Sumam David, *Senior Member, IEEE*

Abstract-- The power quality deterioration is still an unsolved problem due to the increased power electronic load getting into the system. Every, consumer friendly equipment is power electronic controlled in one-way or other. The current drawn by all of these equipments are generally non-sinusoidal in nature, and are distorting the voltage wave as well. Many solutions proposed so far, though found useful in some cases have never become a system solution for the power quality deterioration problem. This paper proposes a unique innovative solution to these problems by a correction at the generation level by changing the shape of source wave keeping in view the nature of new loads. This paper presents PSPICE® simulated results to justify the need for source wave shape change, which will act as a system level solution to the limit peak currents drawn by the new generation power electronic loads.

Index Terms-- Harmonic Torque, Non-sinusoidal excitation, power electronic load, power quality, THD.

I. INTRODUCTION

THE power electronic load in general draws non-sinusoidal currents and are very peaky in nature. Fig. 1a shows a simple one-phase diode bridge rectifier circuit supplying a resistive load through capacitor filter. Fig. 1b and Fig. 1c shows the source current waveform and its harmonic spectrum respectively. The observed source current is only over a definite part of the period for supplying power and current waveform is a discontinuous pulse, highly distorted, and will distort the voltage wave as well. The extent of disturbance in the power system then depends on the type of load and hence characterization becomes extremely complex. The conventional electric power distribution system designed to operate with sinusoidal voltages and currents will tend to become less efficient. Revenue meters become less accurate. Protection devices such as circuit breakers may trip too soon, or too late. A study report [1] says power electronic loads process 10-20% of power generation and this number is expected to reach to 50 to 60 % by 2010. A lot of corrective systems based on different principles like attenuating the bad effects, bypassing the harmonic currents, compensation etc which vary from simple LC filters to active power filters have

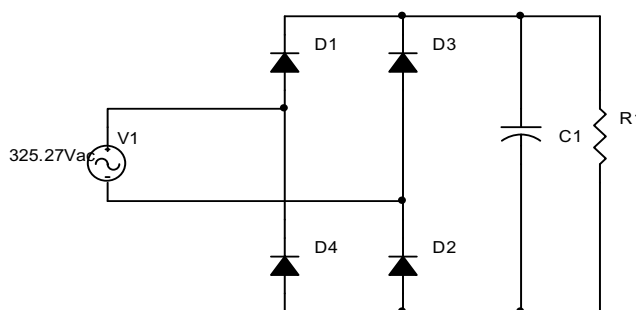

Fig. 1a. Circuit diagram of single - phase diode bridge rectifier.

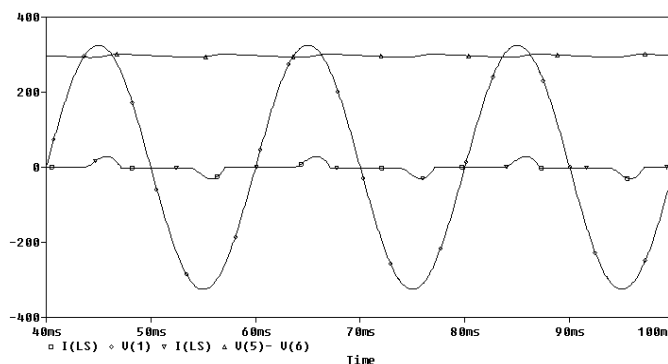

Fig. 1b. Source current and capacitor voltage wave forms.

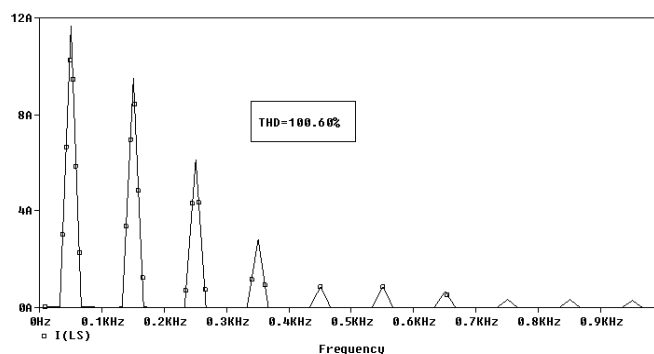

Fig. 1c. Harmonic spectrum of the source current waveform.

been developed by various researchers. LC filters though efficient have poor dynamic response. Also the performance of LC filters depends on source impedance, which in turn depends on the network configuration. A solution like active power filter is relatively more successful for harmonic problems, but it is expensive, and is only a customized solution, either at the load point or at the substation level. Hence it is very much necessary to develop a system level

solution to take care of future loads that have started getting induced into the power system. In this context, this paper proposes a unique system level solution to the basic problem of large peaky currents through a modified source voltage wave shape. PSPICE[®] simulated results are provided to show the effectiveness of modified source wave shape in limiting the peaky currents. The paper also makes an attempt to confirm that the conventional power system equipments like transformer performance does not deteriorate appreciably in the event of utility employing such a wave shape.

II. PRINCIPLE OF OPERATION

A typical nonlinear load is a simple single-phase diode bridge rectifier, supplying load through a capacitive filter [2]. A reasonably large Capacitor filter across the load yields a low ripple dc voltage. As a result, the source current, drawn being very peaky and almost odd harmonic rich in nature. An attempt to convert it nearer to sinusoidal is by widening the charging period of the peaky capacitor current while keeping the amplitude low so that the signal energy levels are same. A careful observation reveals that the sudden rise in current is basically due to the rising source voltage while capacitor is charging. Now if the source voltage is prevented from rising while capacitor is charging i.e. by flattening the source voltage waveform as shown in Fig. 2 the charging current peaks can be greatly reduced. Along with flattening the source voltage the wave magnitude need to be scaled accordingly so that the RMS power delivering capability is unaffected. Thus flattening the source voltage will allow the capacitor to experience a constant source voltage while charging. The source so shaped being non-sinusoidal in nature and will have harmonic components in principle. The modified source voltage wave shape can be expressed by using the Fourier series as below

$$v_o(\omega t) = V_{o1}\sin\omega t + V_{o3}\sin 3\omega t + V_{o5}\sin 5\omega t + \dots \quad (1)$$

where

$$V_{o1} = \frac{2V_m}{\pi} \left[\alpha + \frac{\sin 2\alpha}{2} \right] \quad (2)$$

$$V_{on} = \frac{2V_m}{\pi} \left[\frac{2\sin\alpha \cos n\alpha}{n} + \frac{\sin(n-1)\alpha}{(n-1)} - \frac{\sin(n+1)\alpha}{(n+1)} \right] \quad (3)$$

V_m is the maximum value of the fictitious sine wave, which is flattened at α , and the reference sine wave is defined as $v_s(\omega t) = V_{mR}\sin\omega t$. As stated before the fictitious maximum value of the new flattened sine wave need to be scaled as compared to the reference sine wave having the maximum as V_{mR} , to maintain the same power delivering capability. Table I shows the normalized values of harmonic components of the modified source voltage flattened for different angles. The result of such a flattening is the reduction in the magnitude of peaky source current and the same is shown as normalized values in the Table II, where I_{smax} indicates the peak value of source current and I_{s1max} , I_{s3max} indicates the peak values of fundamental and

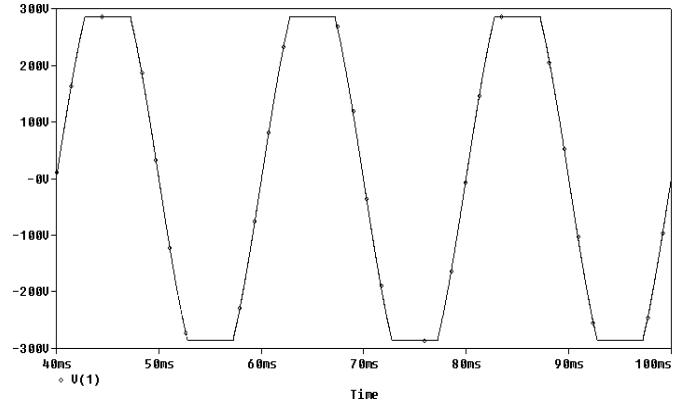

Fig. 2. Proposed source voltage wave shape, flattened at 50°.

the third harmonic components of the source current respectively. Table II also indicates the improvement in distortion factor of the source current.

The results tabulated reveal that, it is just a matter of trade-off between harmonics introduced through source voltage wave shape flattening and current peak reduction. Flattening further the wave will resemble a square wave shape. Hence there exists a bright solution for limiting the peak current demands of the electronic loads through the use of modified source wave shapes. It is very interesting to note that, greater powers can be transmitted through the lines, leading to better line utilization. It is then a question of debate that, if such a wave shape is proposed for the utility supply keeping in view the growing power electronic loads inducted into the utility system, whether the other conventional equipment's of the system will face any problems.

TABLE I

HARMONICS SPECTRUM OF THE RECTIFIER SOURCE VOLTAGE

Angle	V_{o1}	V_{o3}	V_{o5}	V_{o7}	V_s THD (%)
90°	1.00	----	----	---	0.000
80.03°	0.9997	0.0017	0.0016	0.0015	0.312
70.03°	0.9994	0.0155	0.0126	0.0091	2.25
60.24°	0.9982	0.0477	0.0288	0.0106	5.68
50.02°	0.9946	0.0979	0.0366	0.0062	10.48
40.02	0.9866	0.1589	0.0102	0.0265	16.35

TABLE II

HARMONICS SPECTRUM OF THE RECTIFIER SOURCE CURRENT

Angle	I_{smax}	I_{s1max}	I_{s3max}	Distortion factor	THD (%)
90°	1.00	0.388	0.317	0.705	100.60
80.03°	0.979	0.387	0.313	0.712	98.77
70.03°	0.835	0.379	0.288	0.752	87.58
60.24°	0.629	0.364	0.238	0.815	71.07
50.02°	0.48	0.342	0.174	0.889	53.56
40.02	0.381	0.317	0.108	0.935	38.12

The conventional equipments primarily include transformers, induction motors, energy recording meters, heating equipments, lighting products etc. It is henceforth important to make a study of, the effect of modified utility wave shape on the performance of these conventional equipments before it is actually implemented.

As heating equipments work with RMS value of the voltage and hence there will not be any problem in principle as the RMS value of the source voltage is maintained constant. This paper also makes an attempt to study if any bad effects on transformer that might deteriorate the performance. Transformer in principle is an ideal electromagnetic energy conversion device and its performance is decided by the core and winding copper losses, flux saturation characteristics and voltage regulation [3] [4]. The applied voltage wave shape results in self induced electromotive force just due the flux that is set up by the magnetizing current. Therefore the secondary side voltage wave shape depends on the flux magnitude and wave shape. The flux function $\phi(\omega t)$ can be approximately obtained by the integrating the applied voltage wave $v_p(\omega t)$ as

$$v_p(\omega t) = V_{p1}\sin\omega t + V_{p3}\sin 3\omega t + V_{p5}\sin 5\omega t + \dots \quad (4)$$

$$\begin{aligned} \phi(\omega t) = & \phi_{m1}\sin(\omega t - \frac{\pi}{2}) + \phi_{m3}\sin 3(\omega t - \frac{\pi}{2}) + \\ & + \phi_{m5}\sin 5(\omega t - \frac{\pi}{2}) + \dots \end{aligned} \quad (5)$$

$$\begin{aligned} \approx & \frac{V_{p1}}{N_p} \phi_{m1}\sin(\omega t - \frac{\pi}{2}) + \frac{V_{p3}}{3N_p} \sin 3(\omega t - \frac{\pi}{2}) + \\ & + \frac{V_{p5}}{5N_p} \sin 5(\omega t - \frac{\pi}{2}) + \dots \end{aligned} \quad (6)$$

where N_p is the number of primary winding turns. Table III shows the normalized peak amplitudes of the flux wave and the THD for different levels of flattening. Thus the applied wave shape V_p with same RMS value can be expressed as

$$V_p^2 = V_{p1}^2 + V_{p3}^2 + V_{p5}^2 + \dots \quad (7)$$

In which the RMS value of the fundamental component is less than that of the reference wave. Therefore the magnetizing current and hence the operating reactive power requirements are minimized. The higher harmonic impedances limit the harmonic currents and hence their contribution to the flux is very small. In spite of the harmonic fluxes present, the net flux does not increase appreciably. It indicates that there cannot be any saturation problems. The eddy current losses being the resistive losses in eddy current paths, hence RMS value dependent and therefore the performance of transformers do not appear to be deteriorating. If a similar study with the induction motor, when supplied with the proposed wave is made, the performance indicators include the nature of electromagnetic torque produced and the speed-torque characteristics. The Torque in motors is produced by the interaction between the air gap magnetic field and the

rotor-induced currents. When a motor is supplied non-sinusoidal voltage and hence currents, the air gap magnetic fields and the rotor currents contain harmonic frequency components. Positive sequence harmonics like seventh and thirteenth etc produce magnetic fields and currents rotating in the same direction as the fundamental frequency and negative sequence harmonics fifth, eleventh etc develop magnetic fields and currents that rotate in a direction opposite to the positive sequence field. Zero sequence harmonics like multiple of third do not develop usable torque, but produce additional losses in the machine. Thus the oscillatory torque that might be produced in the present context is due to the seventh harmonic than the fifth harmonic and is comparable with that, when supplied from VFD drives. This conclusion is only logical and needs detailed study with appropriate source and machine modeling. This provides a logistic support to say that the induction motors performance also does not deteriorate appreciably.

TABLE III
HARMONICS SPECTRUM FOR THE FLUX WAVEFORM

Angle	ϕ_{m1}	ϕ_{m3}	ϕ_{m5}	ϕ_m	THD (%)
90°	1.00	----	----	1.00	0.000
80.03°	0.9997	0.0006	0.0003	0.9998	0.07
70.03°	0.9994	0.0052	0.0025	0.9878	0.58
60.24°	0.9982	0.0159	0.0058	0.9775	1.75
50.02°	0.9946	0.0326	0.0073	0.9624	3.37
40.02	0.9866	0.053	0.0020	0.9205	5.40

III. SIMULATION

The concept discussed above has been verified using PSPICE® simulations. A single-phase rectifier supplied through a source having proposed wave shape, feeding a resistive load through a capacitive filter. The source with proposed wave shape is developed using piecewise linear model. A filter capacitor $C=4700\mu\text{F}$ and load resistance $R_L=50$ ohm were used with the reference wave is 230V RMS at 50 Hz frequency. Simulations were carried out by maintaining the RMS value at 230V and by flattening the wave for different angles. The simulation results (source current waveforms) are shown in Fig. 3a – Fig. 3f. It is also to be noted that there is a very small decrease in fundamental component of source current drawn, which can be observed in Fig. 4.

IV. CONCLUSION

Modifying the shape of source wave, proposed in this paper as a solution to limit the value of peak harmonic currents of the power electronic load is found to be very encouraging and has the following advantages.

- Lesser current magnitude exchange in the line for the same power supplying capabilities indicates lesser

reactive energy flow in the transmission lines. i.e. the r relatively line voltage profiles will be better [5].

- The peak amplitude of the current wave is decreasing significantly with increased flattening levels.

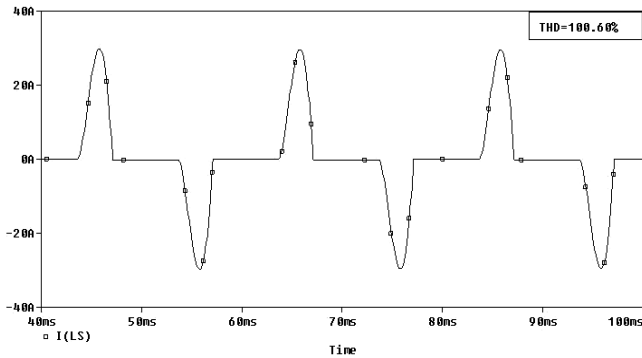
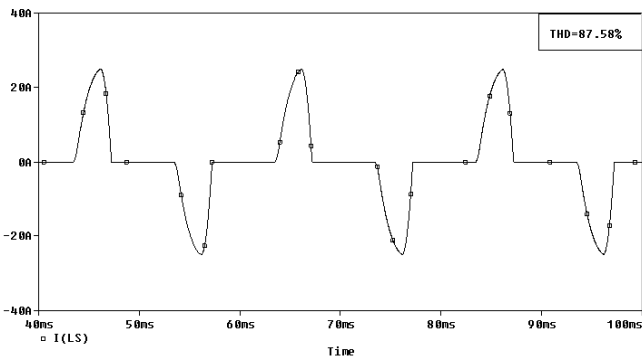

Fig. 3a. Source current waveform for $\alpha = 90^\circ$.



- Since the peak amplitude is reduced the line loading capability can be greatly increased.

- The reduction in the peak current is associated with increase in current distortion factor indicate lesser harmonic current flow in the lines otherwise.

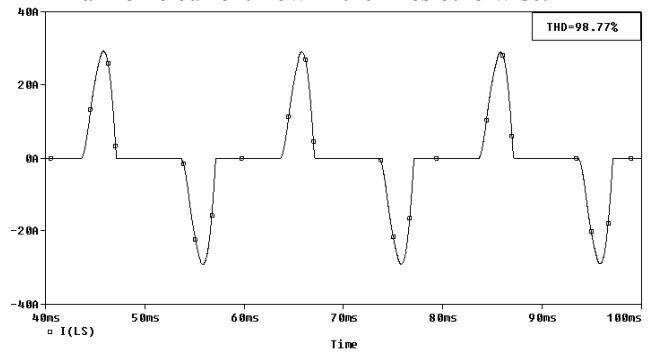

Fig. 3b. Source current waveform for $\alpha = 80^\circ$.

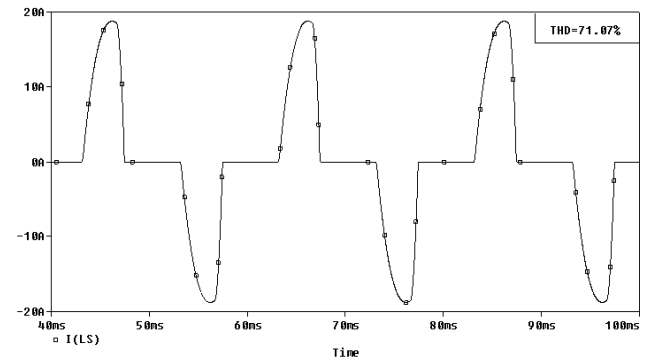

Fig. 3c. Source current waveform for $\alpha = 70^\circ$.

Fig. 3d. Source current waveform for $\alpha = 60^\circ$.

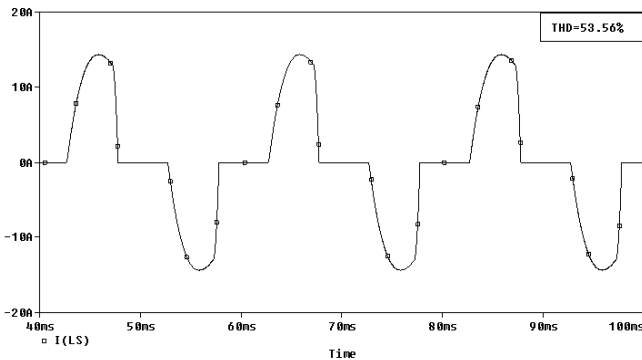

Fig. 3e. Source current waveform for $\alpha = 50^\circ$.

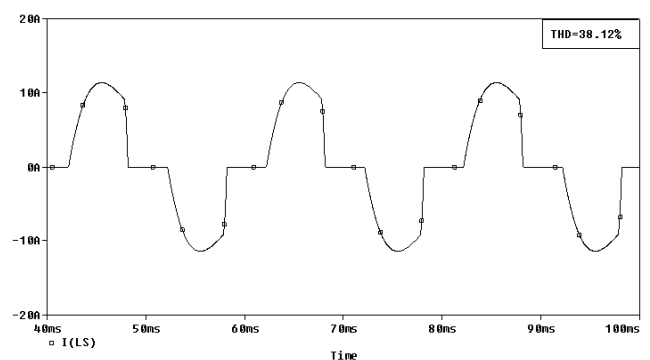

Fig. 3f. Source current waveform for $\alpha = 40^\circ$.

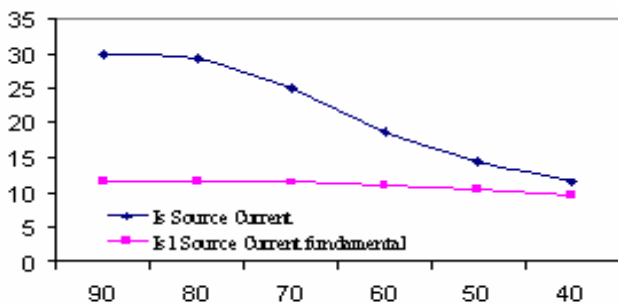

Fig. 4. I_s and I_{s1} variation for different levels of source wave flattening.

- In spite of source voltage wave, having harmonics when applied to a conventionally designed transformer, core saturation does not seem to take place. i.e. the maximum value of the flux wave is expected to be within the design value.

A power factor improvement capacitor if connected across the source will now perform better for the current harmonics drawn from the source. However the source voltage harmonics is still a concern for critically designed equipments. In principle, it has been shown that the proposed wave shape to take care of modern loads will not deteriorate the performance of conventional equipment like transformer,

induction motor etc. Similar study needs to be done for other equipments like energy meters and protection equipments. In addition this opens up the platform for detailed study of the functional behavior of all conventional loads. Also an appropriate strategy needs to be looked into for the generation of such wave shapes.

V. REFERENCES

- [1] M. M. Morcos, and J. C. Gomez, "Electric Power Quality-The strong connection with Power Electronics" *IEEE Power & Energy magazine*, vol. 1, pp.18-25, Sep. / Oct. 2003.
- [2] N. Mohan, Undeland and Robbins, *Power Electronics, converters, Application and Design* John Wiley 1995.
- [3] E.H. Langsdorf, *Theory of alternating current machinery*, TMH, 1994.
- [4] M. G. Say, *Alternating current machinery*, ELBS Publications 1994.
- [5] O.I. Elgerd, *Electric Energy System Theory-An Introduction*, TMH, 1982.

VI. BIOGRAPHIES



Harish Padiyar U. obtained his BE degree and M.Tech from Mangalore University in 1991 and 1997 respectively in the area of Power and Energy Systems.

He is working as Lecturer in the Department of Electrical and Electronics Engineering at Manipal Institute of Technology Manipal. He is presently a PhD student at the Department of Electronics and Communication Engineering, National Institute of Technology Karnataka Surathkal. His research

interests include Power Electronic applications to Electrical Power and Power Quality.



S. S. Mahant Shetti obtained the B.Tech degree in Electrical engineering from IIT Bombay, in 1972 and Masters and PhD degree in Electrical Sciences from Brown University USA, in 1975 and 1977 respectively.

He worked for Texas instruments since 1982, for about 16 years and 3 years for Test Chip Technologies. His areas of interest include VLSI design associated with VHSIC memories, LISP microprocessors, innovative gate architectures, mixed signal design, smart memories etc. He holds 65 patents and currently the chairman of Karnataka Microelectronic Design Center Manipal.



Sumam David S. obtained her B.Tech. Degree from University of Kerala in 1985, and the M.Tech. and Ph.D. degrees from Department of Electrical Engineering, IIT Madras in 1986 and 1992 respectively.

She is presently a Professor in the Dept. of E&C, NITK Surathkal. She was a Visiting Researcher at Dept. of Computation, UMIST, Manchester, UK during 1995-96 and Visiting Professor at School of Advanced Technologies, Asian Institute of Technology Bangkok during 2004. Her research interests are in the areas of Multimedia signal processing and VLSI for Signal processing.